

# Modulo M4

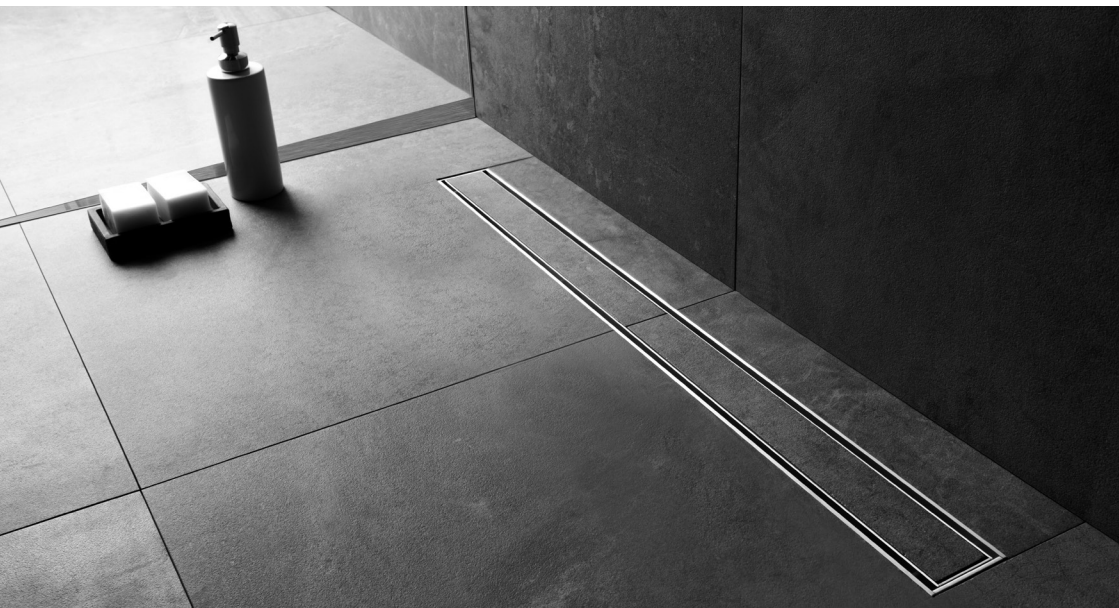

## INSTALLATION ADVICE

- USA Installation advice
- ES Consejo para la instalación
- FR Conseils de montage



# CONTENTS

Contenido

Table des matières

---

Installation options	3
Frame options	3
Height adjustable support	4
Installation guide - Clamp drian	6
Installation guide - No-hub sleeve	8
Sealing	10
Finishing - TAF	11
Finishing - BASIC	13
Installation diagram	14
TAF Extension	17
Maintenance instructions	18
Important assembling advice	19
Installation notes	22

## INSTALLATION OPTIONS

Opciones de instalación

Variantes de montaje

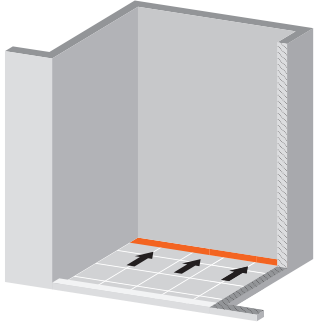

Along the wall | Wall mounted

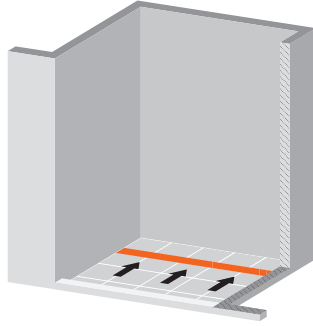

Centered | Wall-to-Wall

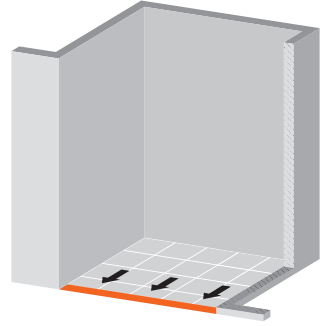

At the entrance

## FRAME OPTIONS | MODULO

Opciones de marco

Opciones de cadre

TAF (Z1)



TAF WALL



DESIGN (Z2)



DESIGN (Z3)



DESIGN (Z4)



## HEIGHT ADJUSTABLE SUPPORT

Montaje del pie de ajuste

Socle de montage ajustable

### ⚠ CLAMP DRAIN & DRAIN SUPPORT

It is not recommended to use any supporting feet when installing the Modulo with bottom outlet in combination with a clamp drain. Make sure the outlet can be fitted tightly in the gasket of the clamp drain. When using these adjustable feet there should be at least  $1\frac{9}{16}$ " (40 mm) height difference between the top of the pan liner and the bottom of the Modulo rough.

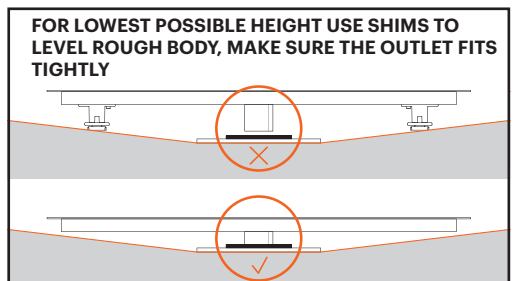
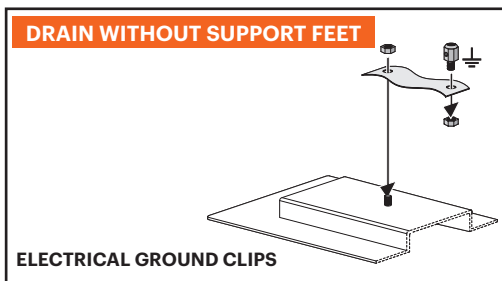
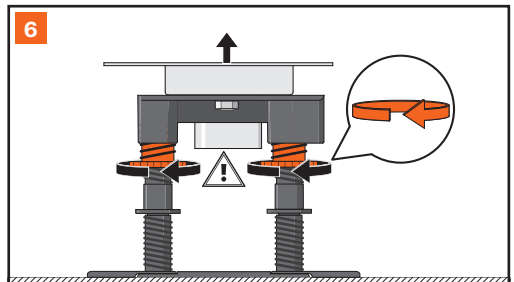
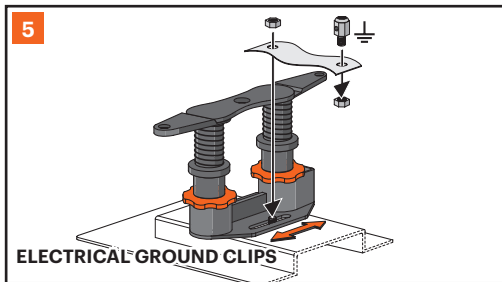
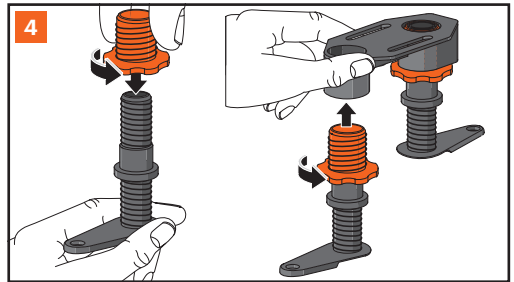
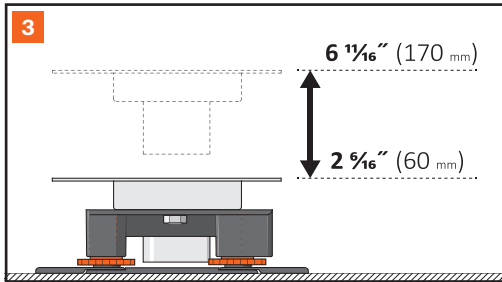
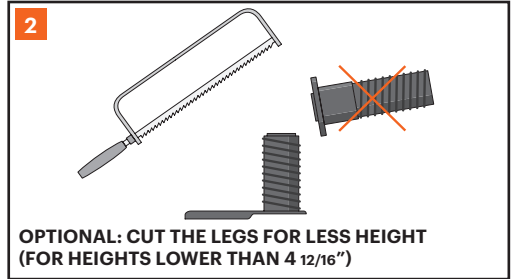

# HEIGHT ADJUSTABLE SUPPORT - WALL

Montaje del pie de ajuste - Pared

Socle de montage ajustable - Mur

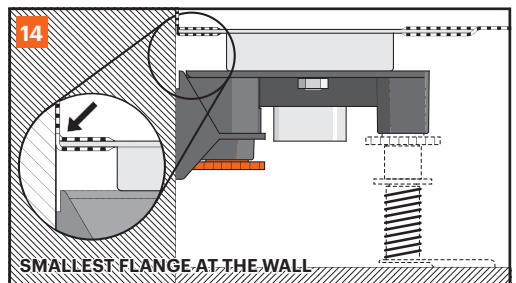
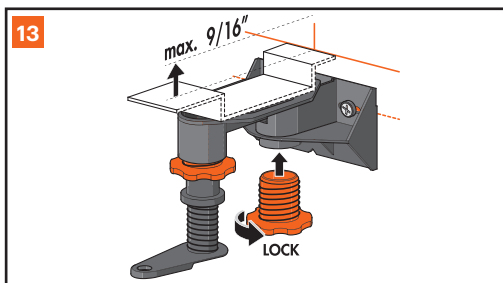
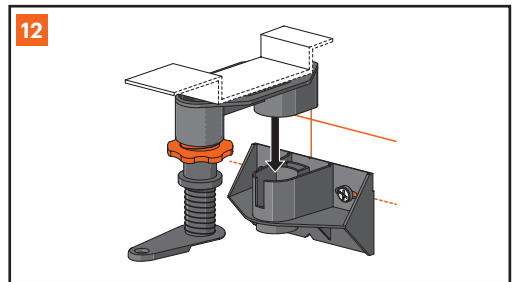
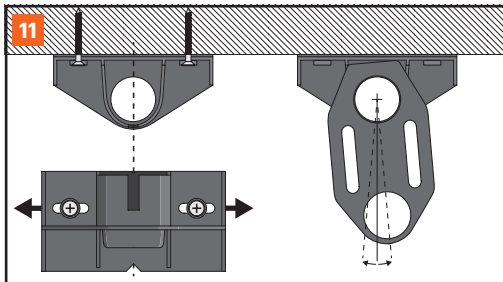
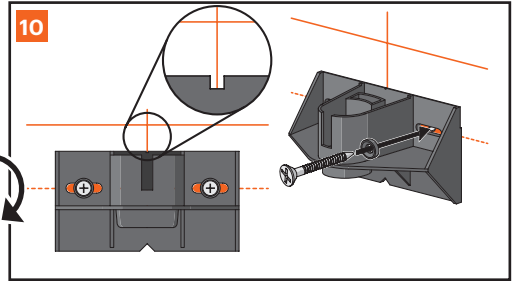
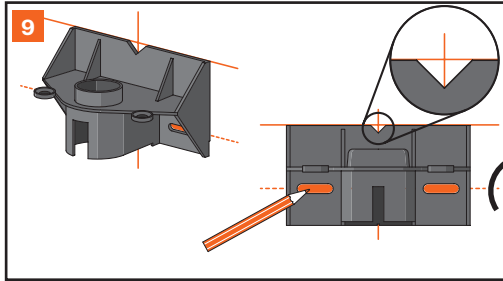
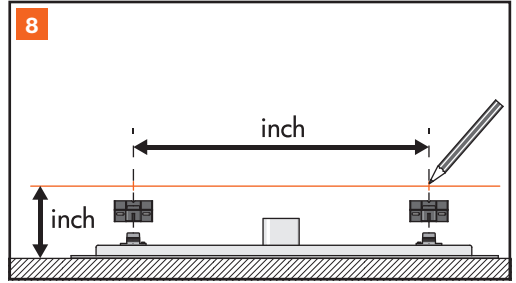
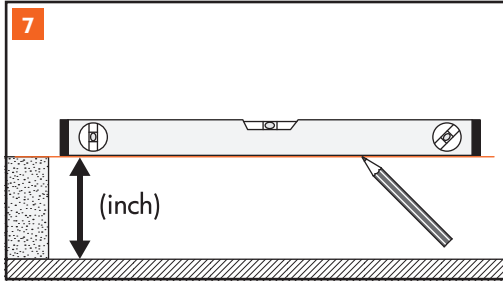

# INSTALLATION GUIDE - CLAMP DRAIN

Manual de instalación

Explications de montage

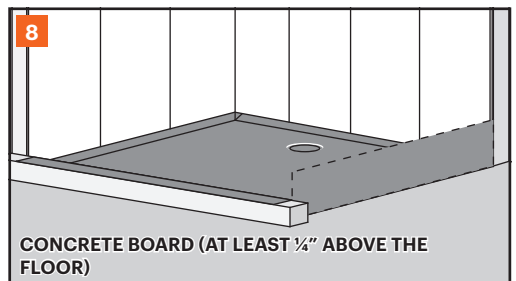
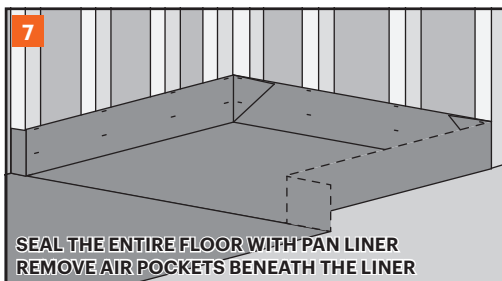
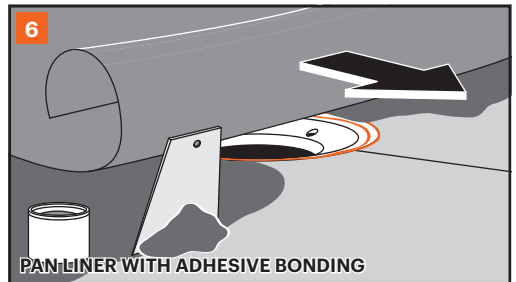
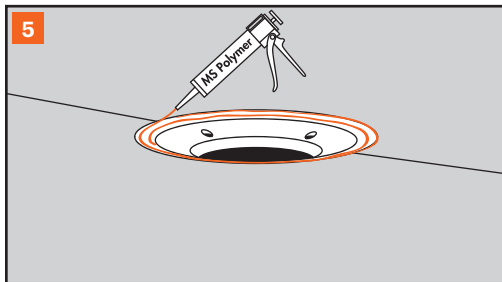
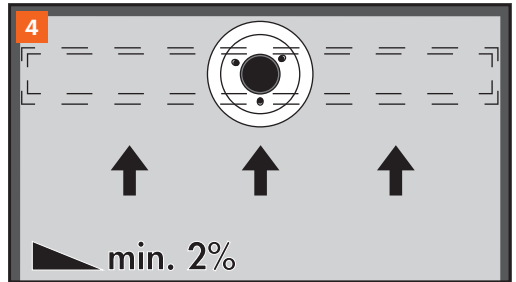
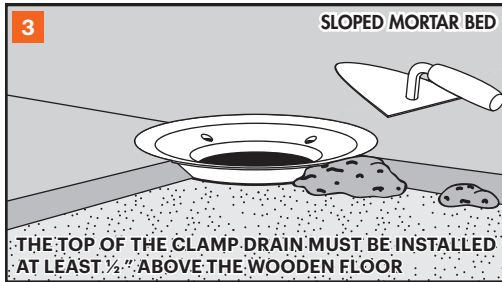
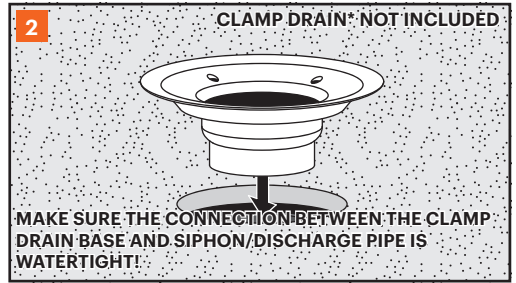
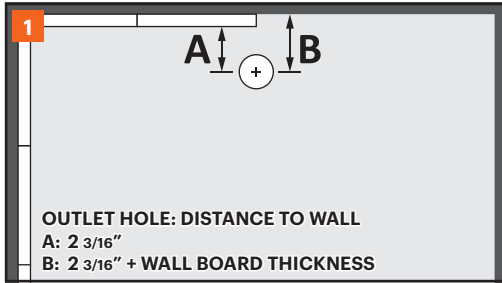

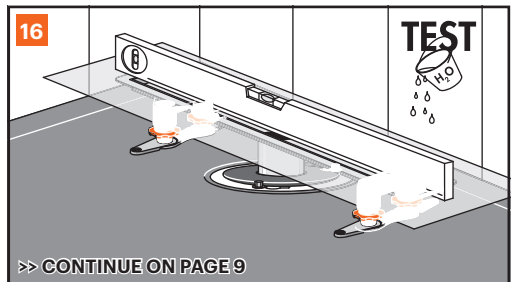
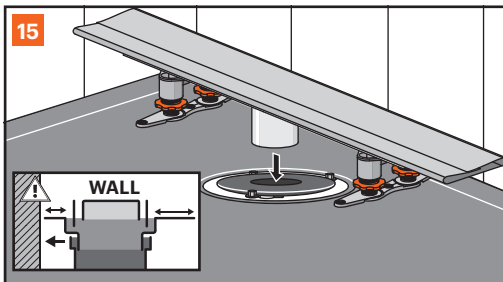
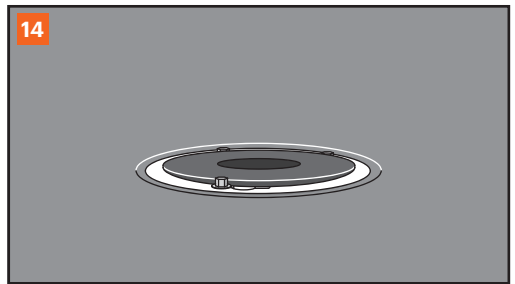
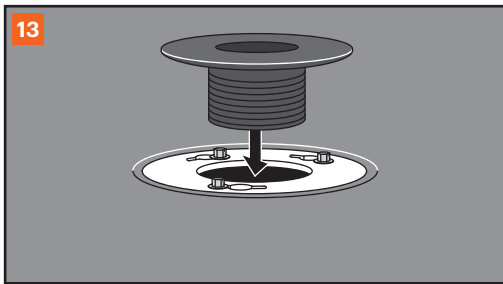
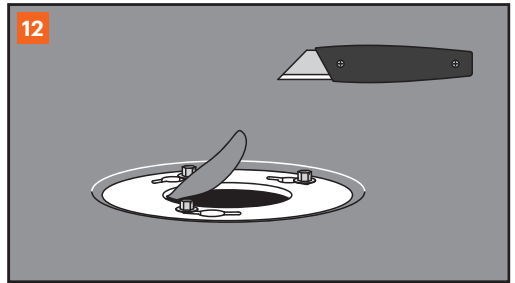
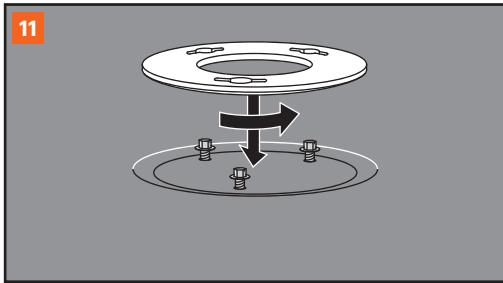
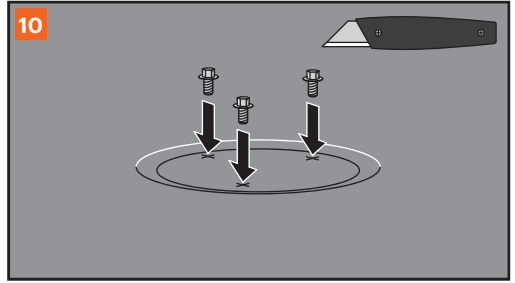
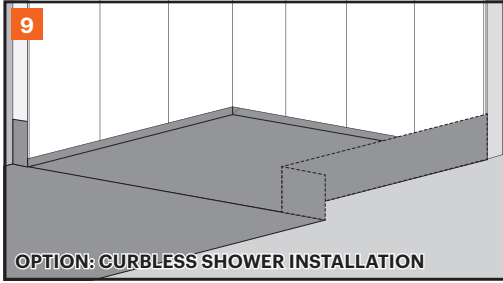

# INSTALLATION GUIDE WALL- NO-HUB SLEEVE

Manual de instalación

Explications de montage

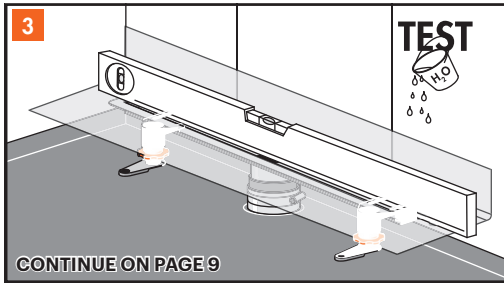
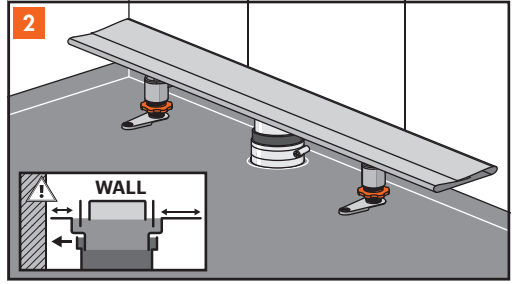
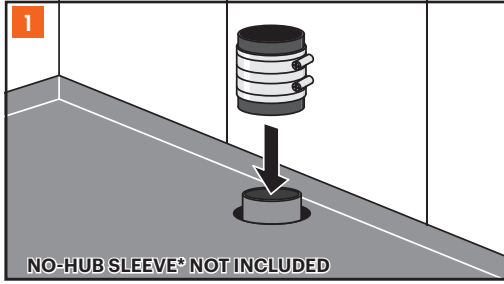



# INSTALLATION GUIDE

Manual de instalación

Explications de montage

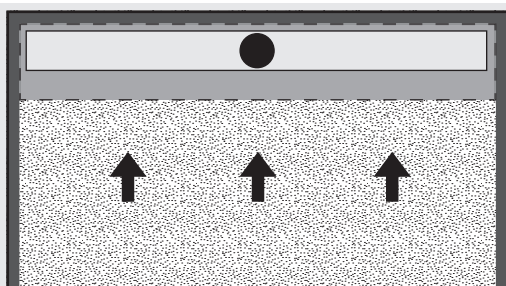
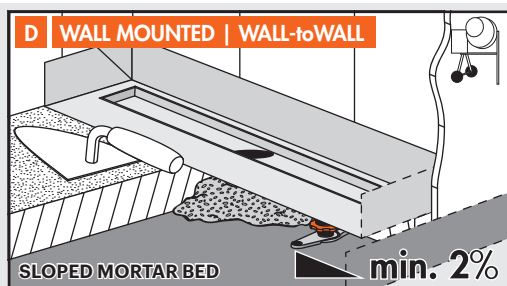
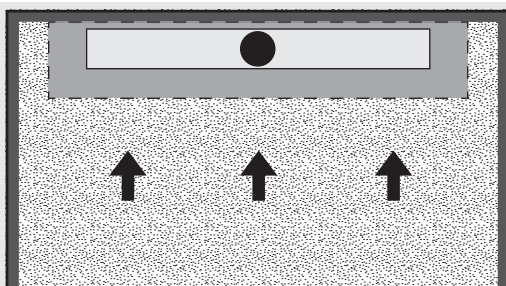
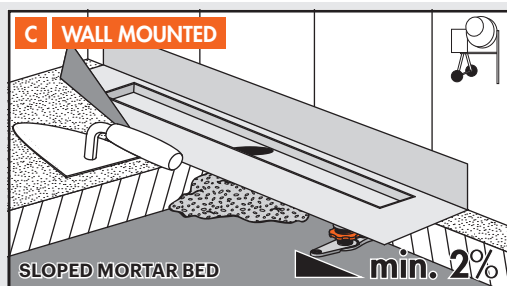
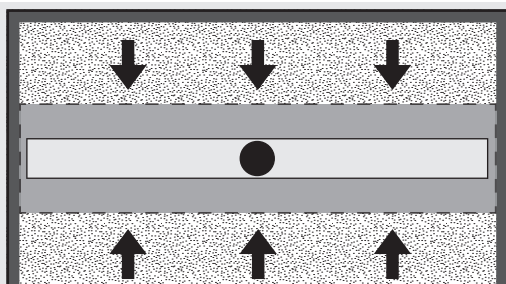
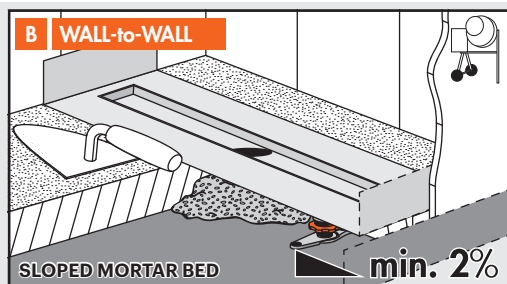
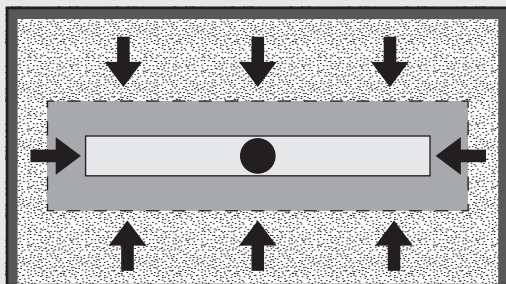
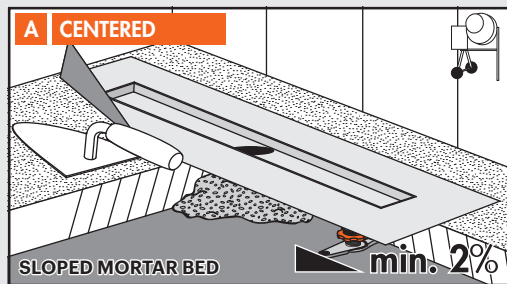

# SEALING

Impermeabilizante  
d'Étanchéité

All sealing instructions are similar for every type of installation, e.g. centered, wall-to-wall etc. Only the way in which the waterproofing membrane is fitted to the walls differs between the various types of installation (see drawing on page 9).

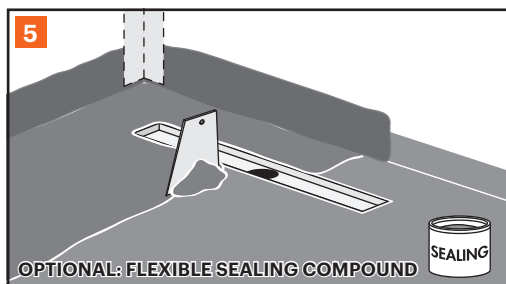
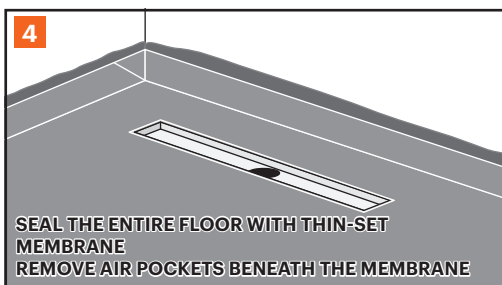
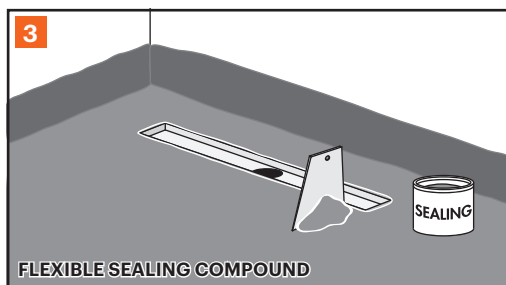
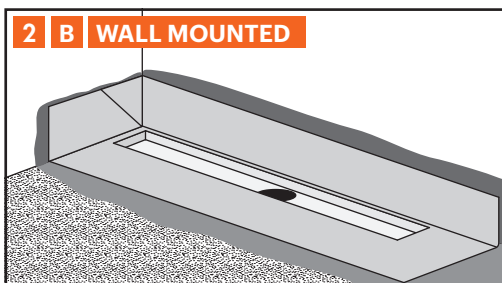
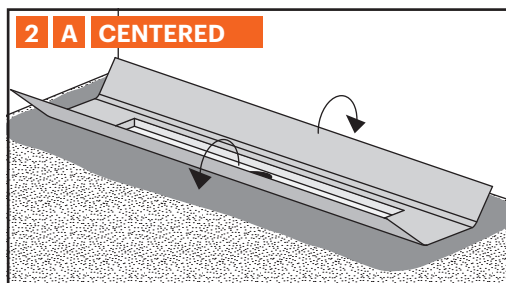
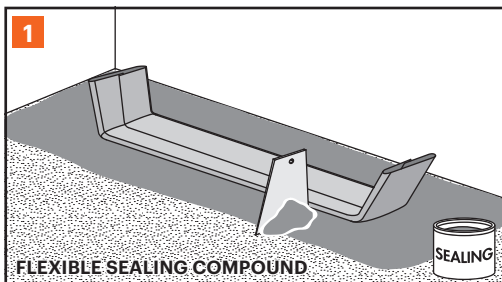

# FINISHING - TAF

Acabamiento - TAF

Finition - TAF

Depending on installation, TAF extension flanges can be removed or used for wall-to-wall installation. In wall-to-wall installation, wall tiles are placed upon the TAF flanges for a perfect fit between the wall tiles, floor tiles and the drain. Extension flanges, which extend the total length up to 4", are available for sale. **Determine which flanges need to be mounted. Mount flanges before installation!**

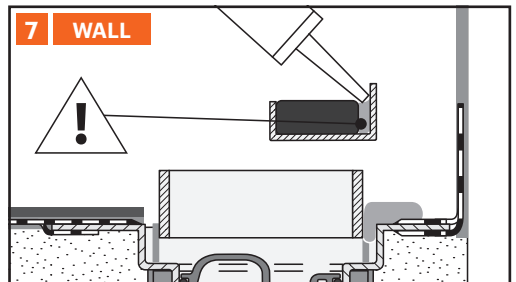
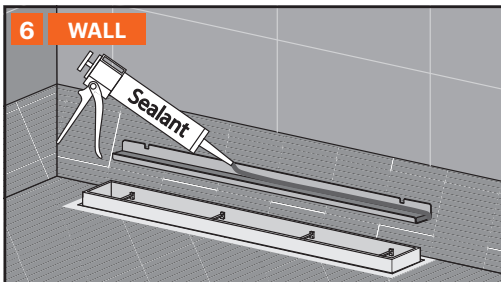
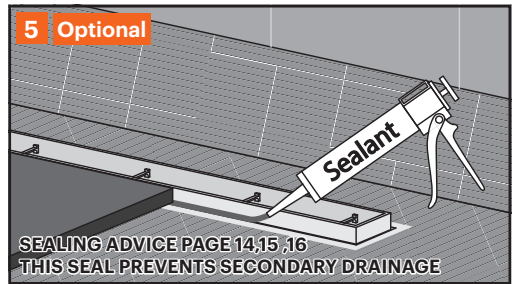
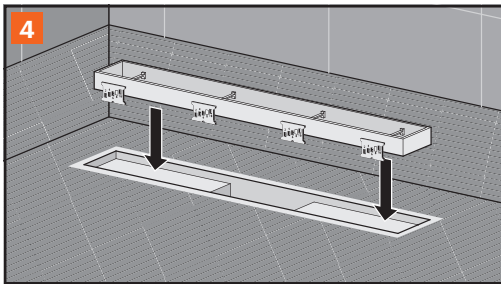
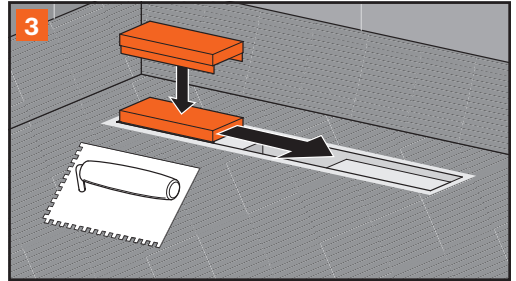
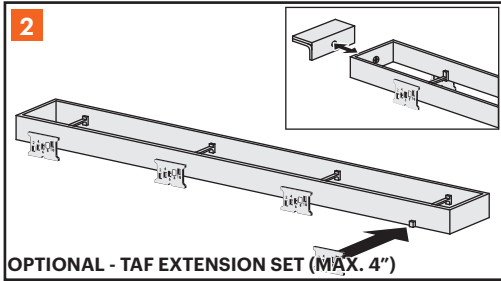
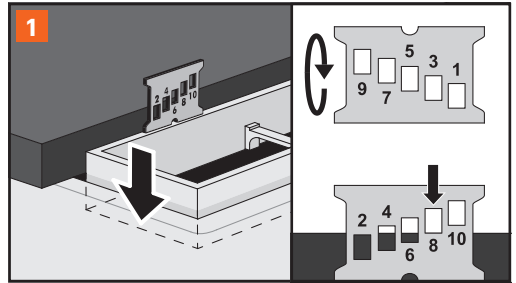

# Easy Drain®

by ess

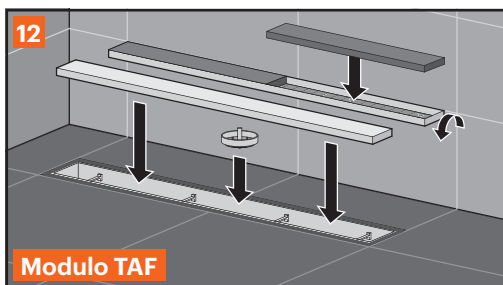
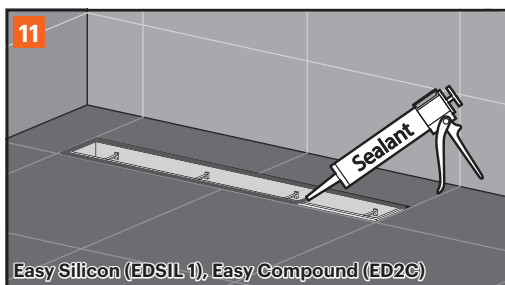
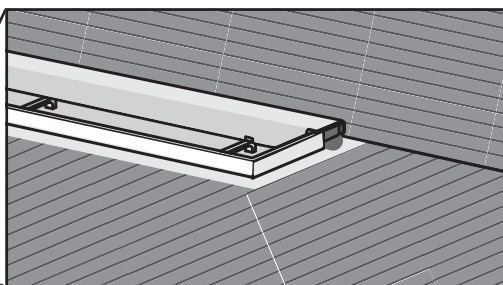
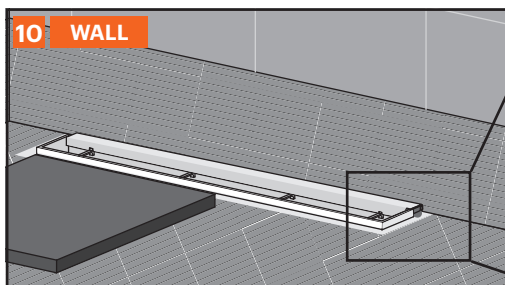
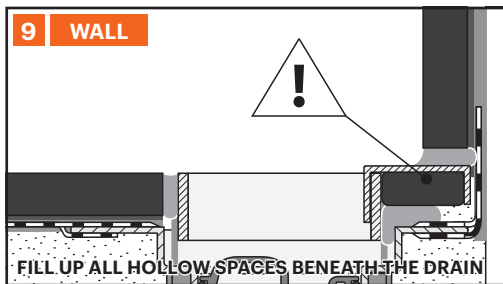
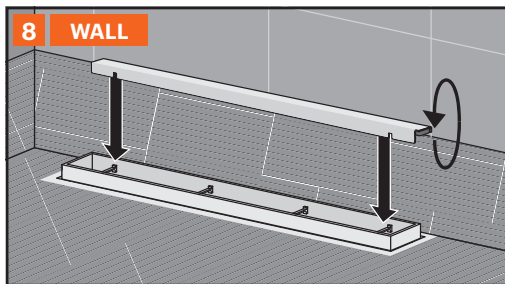

# FINISHING - BASIC

Acabamiento - BASIC

Finition - BASIC

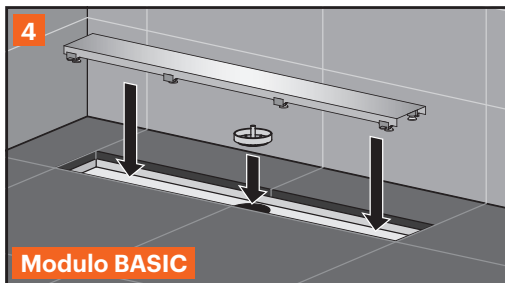
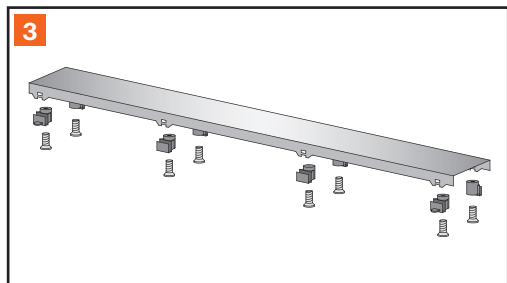
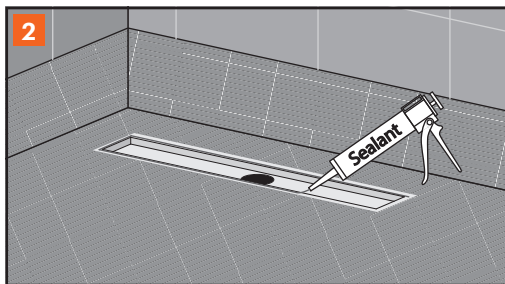
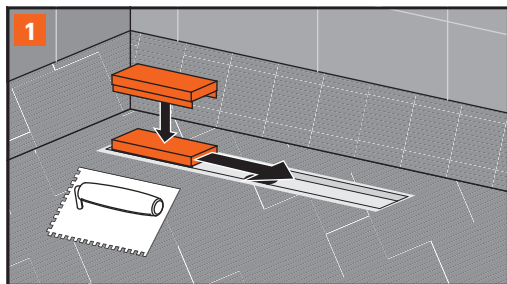

# INSTALLATION DIAGRAM

# CLAMP DRAIN

Diagrama de instalación

Schéma d'installation

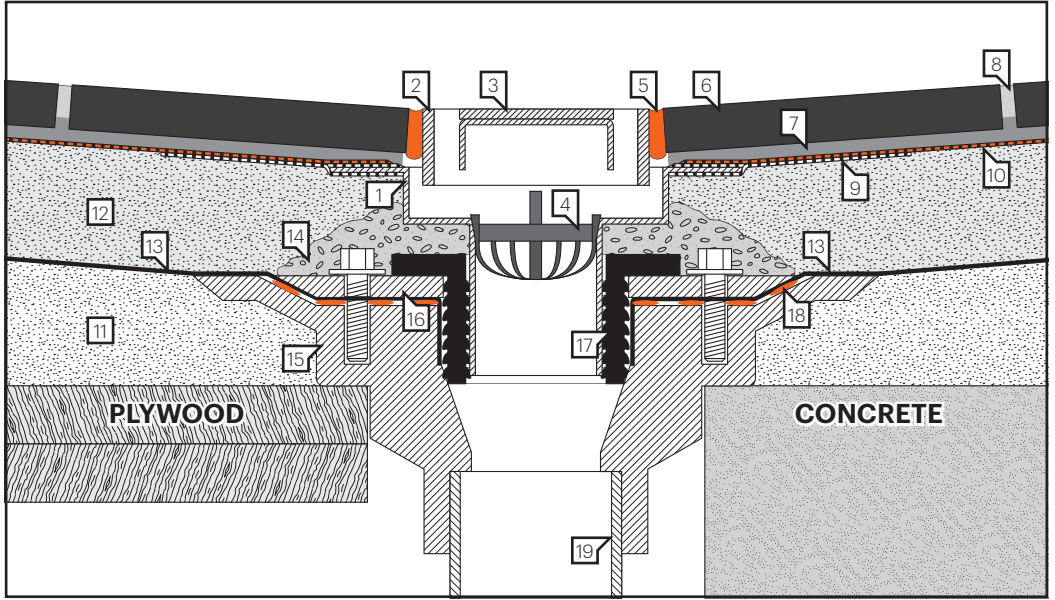

1	Modulo drain body
2	TAF (Tile Adjustable Frame)
3	TAF Grating
4	Strainer
5	Elastic sealant - Silicone
6	Tiles
7	Thin set tile adhesive
8	Grout
9	Pre-assembled waterproofing membrane
10	Thin-set sheet membrane (entire floor!)

11	Sloped mortar bed - first layer
12	Sloped mortar bed - second layer
13	Pan liner / Moisture resistant material
14	Pea Gravel
15	2" Clamping drain base*
16	2" Clamping ring*
17	2" Rubber sealing gasket
18	Sealant between membrane & mortar
19	Drainage pipe

\*Not included with the drain.

# INSTALLATION DIAGRAM - WALL

# NO-HUB SLEEVE

Diagrama de instalación - Pared

Schéma d'installation - Mur

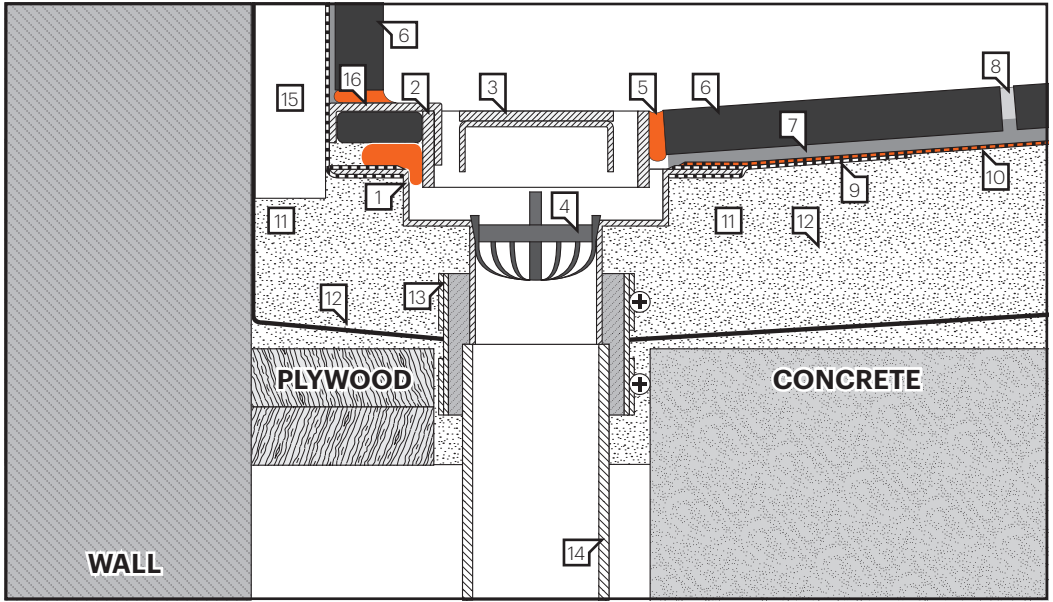

1	Modulo drain body
2	TAF (Tile Adjustable Frame)
3	TAF Grating
4	Strainer
5	Elastic sealant - Silicone
6	Tiles
7	Thin set tile adhesive
8	Grout

9	Pre-assembled waterproofing membrane
10	Thin-set sheet membrane (entire floor!)
11	Sloped mortar bed - first layer
12	Pan liner / Moisture resistant material
13	No-Hub sleeve*
14	Drainage pipe
15	Concrete board
16	TAF wall profile

\*Not included with the drain.

# INSTALLATION DIAGRAM

# NO-HUB SLEEVE

Diagrama de instalación

Schéma d'installation

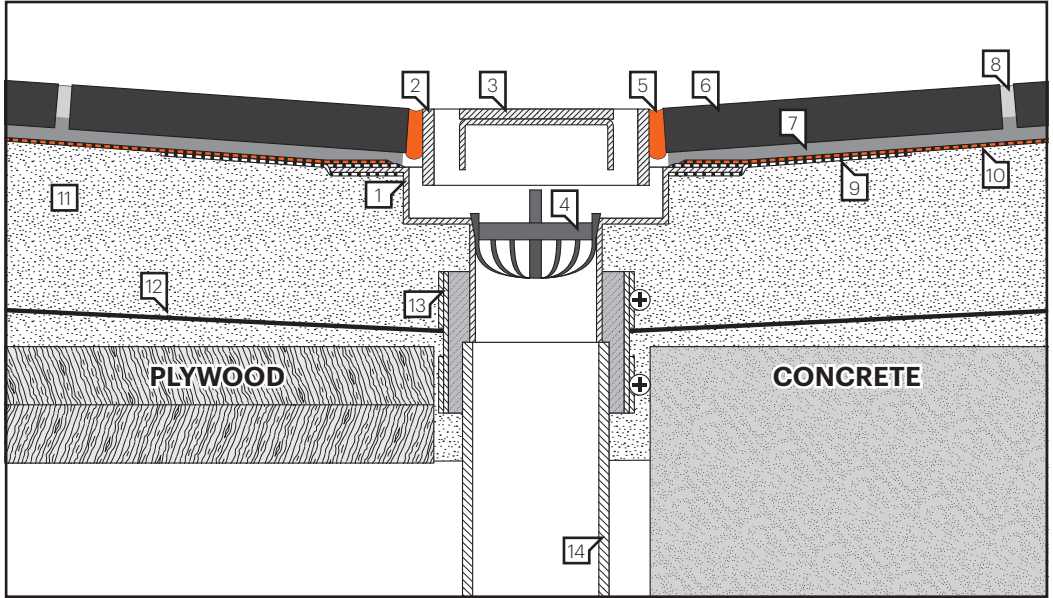

1	Modulo drain body
2	TAF (Tile Adjustable Frame)
3	TAF Grating
4	Strainer
5	Elastic sealant - Silicone
6	Tiles
7	Thin set tile adhesive

8	Grout
9	Pre-assembled waterproofing membrane
10	Thin-set sheet membrane (entire floor!)
11	Sloped mortar bed - first layer
12	Pan liner / Moisture resistant material
13	No-Hub sleeve*
14	Drainage pipe

\*Not included with the drain.



# TAF EXTENSION SET (WALL-TO-WALL)

Manual de instalación

Explications de montage

The Easy Drain TAF frame is delivered with two standard flanges attached. To extend the frame length, unscrew the flanges and connect the extension set pieces (not included). All TAF Extension sets consist of two equal size flanges.

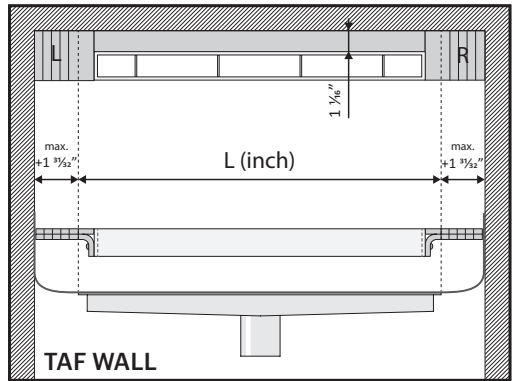
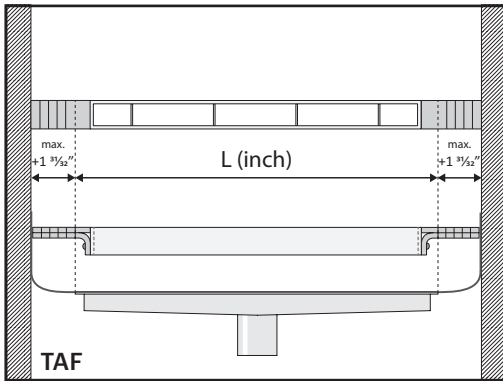
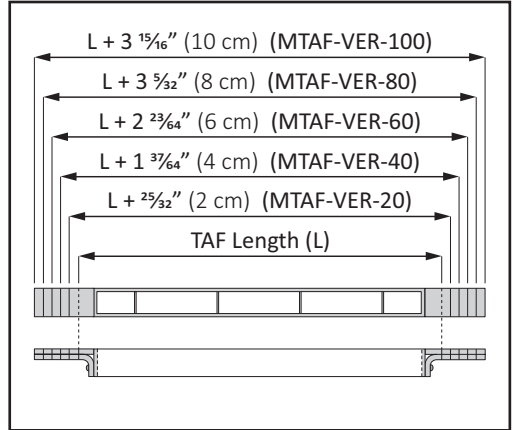
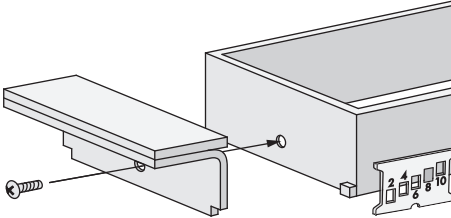

	Single flange size	Total extension (set)	Product code (TAF)	Product code (TAF Wall)
<b>STD</b>	7/8" (21 mm)	Up to drain length	MTAF-VER-STD	MTAFW-VER-STD
<b>A</b>	3/8" (10 mm)	4/5" (20 mm)	MTAF-VER-20	MTAFW-VER-20
<b>B</b>	4/5" (20 mm)	1 5/9" (40 mm)	MTAF-VER-40	MTAFW-VER-40
<b>C</b>	1 1/5" (30 mm)	2 3/8" (60 mm)	MTAF-VER-60	MTAFW-VER-60
<b>D</b>	1 5/9" (40 mm)	3 1/8" (80 mm)	MTAF-VER-80	MTAFW-VER-80
<b>E</b>	1 8/9" (50 mm)	3 8/9" (100 mm)	MTAF-VER-100	MTAFW-VER-100

## MAINTENANCE INSTRUCTIONS

Instrucciones de mantenimiento

Instructions d'entretien

---

- USA**
- Do not use abrasives and/or sharp/scraping objects to clean the Modulo®.
  - The siphon trap should be cleaned periodically to remove any dirt that may have collected.
  - We recommend the use of EasyClean Set (ED-SC) for daily maintenance and cleaning of your Modulo®.

- ES**
- Limpiar el Modulo® sin utilizar productos corrosivos y/o materiales abrasivos.
  - Limpiar periódicamente los posibles residuos del cierre hidráulico.
  - Se recomienda el uso de EasyClean Set (ED-SC) para el mantenimiento diario y limpieza intensiva de su A Modulo®.

- FR**
- N'utilisez pas de produit abrasifs ni d'objets coupants ou abrasifs pour le nettoyage du Modulo®.
  - Éliminez périodiquement les dépôts éventuels au niveau du coupe-odeur.
  - Nous conseillons d'utiliser EasyClean Set (ED-SC) pour la maintenance quotidienne et le nettoyage intensif du Modulo®.

## Important assembling advice: Modulo®

Suitable for renovation work and new construction

Modulo should only be installed by specialist companies in compliance with the building regulations. To achieve the best possible result, please carefully read the installation guide. If you have any questions, please consult your supplier.

- Please check the content of the package for completeness and integrity before proceeding with the assembly. Do not install the drain if any deviations are noted. Should this be the case, please consult your supplier.
- Prior to the assembly, the assembling advice and its special characteristics should be discussed with the tiler. After the assembly, please provide the tiler with the complete assembling advice.
- If the drain is used for several showers, please check to make sure that the drainage capacity is sufficient. If you are unsure, please consult the supplier for advice.
- If you are not using the second drainage level (secondary water drainage), the joint between the shower drain and the tile frame should be sealed with a permanent sealer.
- We recommend taping or closing the drain opening of the shower drain with a cement cap prior to the assembly to prevent construction debris from getting into the drainage pipe. To prevent damage to the tile frame, it should be kept in the package until the final installation by the tiler.
- Make sure the drain is level all around.
- Install the sewage system in compliance with the standards. **Note:** ensure that the sewage system is well ventilated and that the gradient is sufficient.
- Check the drainage system and the sewer system connection for tightness.
- In order to prevent hollow spaces, the drain must be fully lined and sealed with floor pavement to the upper edge of the flange.
- The seal is applied in compliance with general standards for indoor sealing of wet areas. If alternative seals are used, please read the manufacturer's product information.
- When tiles are being fitted, the gradient of the tiles (min. 2% per linear metre) in the shower must always be towards the drain. The tiles should be laid level or 1 mm higher than the top edge of the tile frame to ensure good drainage toward the shower drain. **Note:** the requirements with regard to the floor gradient may be different for walk-in showers with glass walls. Please consult your supplier in this respect.
- Once the tiles have been fitted, the joint between the tiled floor and the drain should be permanently sealed with an elastic sealant (maintenance joint). The adhesion surfaces should be free of mortar, adhesive and other adhesion-reducing materials.
- The drain is only intended for use with waste water common in households. Do not use other fluids as well as cleaning agents with the potential to damage sanitary equipment, drainage equipment and raw materials.
- If the drain is used for other purposes (e.g. swimming pools), where it may come in contact with aggressive cleaning agents or corrosive substances such as salt or chlorine, please consult your supplier.
- Compliance with this installation advice is required for any warranty claims based on our sale and delivery terms.

### Caution !

- Tile cleaning products often contain aggressive chemicals that are abrasive in nature and may damage the drain. Please ensure that the drain is thoroughly flushed after using any tile and grout cleaning products.

Typing and printing errors reserved. Easy Sanitary Solutions BV excludes all liability for any damages whatsoever associated with the use and/or the installation of the drain. Easy Sanitary Solutions BV a priori excludes any liability whatsoever.

## Consignes de montage importantes: Modulo<sup>®</sup>

Pour les nouvelles constructions et pour les projets de rénovation

Le montage de le Modulo devra, dans le respect des règles de la construction, être réalisé uniquement par une entreprise spécialisée. Pour obtenir un résultat optimal, veuillez lire attentivement les instructions de montage. Pour toutes questions éventuelles, veuillez consulter votre fournisseur.

- Avant d'entreprendre le montage, il est nécessaire de vérifier que le contenu de l'emballage est complet et intact. Si tel n'est pas le cas, l'écoulement ne devra pas être installé. Veuillez alors prendre contact avec votre fournisseur.
- Avant d'entreprendre le montage, il est nécessaire de discuter avec le carreleur des consignes de montage et de leurs particularités. Après le montage, veuillez remettre toutes les consignes de montage au carreleur.
- Si l'écoulement doit desservir plusieurs douches, veuillez vérifier qu'il présente une capacité d'écoulement suffisante. Le cas échéant, demandez conseil à votre fournisseur.
- En cas de non-utilisation du deuxième niveau d'écoulement (évacuation secondaire), le joint entre le corps du caniveau de douche et le cadre à carrelé devra être colmaté au moyen d'un mastic d'étanchéité durable.
- Nous vous recommandons, avant de procéder au montage, d'obturer l'orifice d'écoulement du caniveau de douche avec un ruban adhésif ou avec la coiffe de protection contre le ciment pour prévenir la présence de souillures dans la canalisation d'écoulement. Pour éviter les détériorations, le cadre à carrelé devra rester dans son emballage jusqu'à son montage final par le carreleur.
- Ajuster l'écoulement à l'horizontale dans toutes les directions.
- La mise en place de l'installation d'écoulement devra être réalisée conformément aux normes. **Remarque:** tenez compte de l'aération et veillez à donner une déclivité suffisante à l'installation d'évacuation d'eau.
- Vérifier l'étanchéité du système d'écoulement et des raccordements d'eaux usées.
- Pour éviter la formation de cavités, il est nécessaire de mettre en œuvre le mortier de chape sous toute la surface du corps de l'écoulement, jusqu'à l'arête supérieure de la bride, et de le tasser.
- L'étanchéité sera réalisée suivant la norme de construction. En cas d'utilisation d'autres matériaux d'étanchéité à titre d'alternative, il est nécessaire de tenir compte des informations produit du fabricant.
- Lors de la pose du carrelage de sol, la déclivité (au min. 2% par m<sup>2</sup>) dans la zone de douche devra toujours être orientée vers l'écoulement. Les carrelages posés doivent affleurer l'arête supérieure du cadre à carrelé ou dépasser celle-ci de 1 mm, ce qui garantit un bon écoulement de l'eau vers le caniveau de douche. **Remarque:** dans les douches de plain-pied à parois vitrées, il est possible que la déclivité obéisse à d'autres exigences. Sur ce point, veuillez vous adresser à votre fournisseur.
- Après la pose du carrelage, il est nécessaire d'étanchéifier durablement le joint entre le sol carrelé et l'écoulement au moyen d'un joint élastique (joint d'entretien). Les surfaces de collage doivent être exemptes de mortier, de colle et autres substances susceptibles de nuire à l'adhérence.
- L'écoulement est uniquement apte à recevoir les eaux usées domestiques habituelles. Évitez tous autres liquides ainsi que les produits de nettoyage susceptibles d'endommager les équipements sanitaires, les dispositifs d'évacuation d'eau et le matériel des tuyauteries.
- En cas d'utilisation de l'écoulement dans d'autres domaines (piscine, par exemple) dans lesquels il pourrait se trouver en contact avec des produits de nettoyage agressifs ou des substances favorisant la corrosion, telles que le sel ou le chlore, veuillez prendre contact avec votre fournisseur.
- Le respect des présentes recommandations de montage est la condition préalable de l'exercice du droit à la garantie sur la base de nos Conditions générales de vente et de livraison.

### Attention !

- Les produits nettoyants pour carrelages contiennent souvent des substances chimiques agressives. Ces substances peuvent attaquer la surface du caniveau. En cas d'utilisation de produits nettoyants pour carrelages et pour joints, veillez à procéder ensuite à un nettoyage suffisant de l'écoulement.

Sous réserve de fautes d'impression. Easy Sanitary Solutions BV n'assume aucune responsabilité pour tous dommages résultant de l'utilisation et/ou du montage du caniveau de douche. Easy Sanitary Solutions BV exclut d'avance toute responsabilité.

## Indicaciones importantes de colocación: Modulo®

Adecuado tanto en los edificios de nueva construcción como en la de renovación

Únicamente una empresa especializada puede colocar el Modulo y siempre teniendo en cuenta las disposiciones técnicas de instalación. Para que la colocación resulte satisfactoria, lea las indicaciones de montaje cuidadosamente. En caso de consultas, póngase en contacto con su proveedor.

- Antes de comenzar con el montaje, verifique que la caja esté completa y que su contenido esté íntegro. Si hubiera diferencias, no coloque el desagüe. En ese caso, contáctese con su proveedor.
- Antes de comenzar con el montaje, converse las particularidades de las indicaciones de colocación con el colocador de baldosas. Después de la colocación, entréguele las indicaciones de montaje del drenaje al colocador de baldosas.
- En caso de utilizar el drenaje para varias duchas, verifique que la capacidad de descarga del desagüe de la ducha sea suficiente. Si fuese necesario, solicite asesoramiento a su proveedor.
- Si el segundo nivel de salida no será utilizado (desagüe de agua secundario), selle la junta entre el cuerpo del drenaje de la ducha y el marco de baldosas con material impermeable duradero.
- Le recomendamos que adhiera el orificio de salida del desagüe de la ducha antes del montaje o que lo tape con cemento, para evitar que el desagüe de salida se ensucie. Para evitar roturas, el marco de baldosas debe permanecer en la caja hasta que el colocador de baldosas termine con el montaje final.
- Nivele el drenaje en forma horizontal en todas las direcciones.
- La instalación del equipo de desagüe debe realizarse conforme a las normas. **Nota:** tenga en cuenta la aireación y la ventilación y que el declive del desagüe sea suficiente.
- Controle la estanqueidad del sistema de descarga y de las conexiones del desagüe.
- Para evitar espacios vacíos, se debe llenar e impermeabilizar el cuerpo del drenaje completamente hasta el borde superior de la brida y el solado.
- La impermeabilización debe realizarse según las disposiciones estándar de construcción. Al utilizar juntas alternativas, se debe tener en cuenta la información de producto del fabricante.
- Al colocar las baldosas del suelo, el desnivel de las baldosas (mínimo 2% cada m1) del área de la ducha siempre debe correr hacia la descarga. Las baldosas deben colocarse a la misma altura o 1mm más arriba del borde superior del marco de las baldosas. De esta manera, se garantiza un buen desagüe hacia el drenaje de la ducha. **Nota:** en caso de duchas en el mismo nivel del suelo con paneles de vidrio, es posible que para los desniveles sea necesario tener en cuenta otros requisitos. Consulte a su proveedor al respecto.
- Después de colocar las baldosas, el paso entre el suelo de baldosas y la descarga debe impermeabilizarse con una junta elástica (junta de dilatación) en forma permanente. Las superficies adherentes deben estar libres de mortero, adhesivo y otros materiales que disminuyan la adhesión.
- El sistema de descarga solo es apto para desagotar las duchas habituales para el hogar. Evite cualquier otro líquido y productos de limpieza, que puedan dañar el equipamiento sanitario, los elementos del desagüe y el material de los caños.
- Si se utiliza la descarga en otras áreas (por ejemplo, en piscinas), en las que la descarga entre en contacto con productos de limpieza agresivos o sustancias corrosivas, tales como sal o cloro, póngase en contacto con su proveedor.
- Seguir esta recomendación de montaje es requisito para hacer uso del derecho de garantía, de acuerdo con nuestras condiciones de venta y de entrega.

### Atención!

- Frecuentemente, los productos de limpieza de baldosas contienen químicos agresivos, que pueden dañar la superficie del drenaje. Tenga en cuenta que, si utiliza productos de limpieza de baldosas y juntas, posteriormente deberá limpiar profundamente la descarga.

Queda reservado cualquier error de impresión y de redacción. Queda excluida cualquier responsabilidad de Easy Sanitary Solutions BV por daños que se produzcan por el uso y/o colocación del drenaje de la ducha. Easy Sanitary Solutions BV queda eximida de cualquier responsabilidad a priori.





Sales:

**Easy Drain® USA Collection**

561 Acom Street, Unit M

Deer Park, NY 11729

T: 001-(888) 317-7927

F: 001-(888) 488-1617

email: sales-usa@esspost.com

[www.easydrainusa.com](http://www.easydrainusa.com)



Manufacturer:

**Easy Sanitary Solutions**

Nijverheidsstraat 60

7575 BK Oldenzaal, The Netherlands

tel: +31 (0)541 200800

email: info@esspost.com

[www.easydrain.com](http://www.easydrain.com)

ESS PRODUCTS ARE PATENTED AND REGISTRATED TRADEMARKS MADE BY ESS



E60.03.12.00.08

2020 rev.1